

Pull Handle

Model: HW-RH600CP

- Size: 24"
- BRASS INSERTS
- BRASS COLLARS
- SOLID STAINLESS STEEL WASHERS
- STAINLESS STEEL BOLTS & SCREWS
- STAINLESS STEEL 304 CONSTRUCTION
- FINISH: CHROME POLISHED

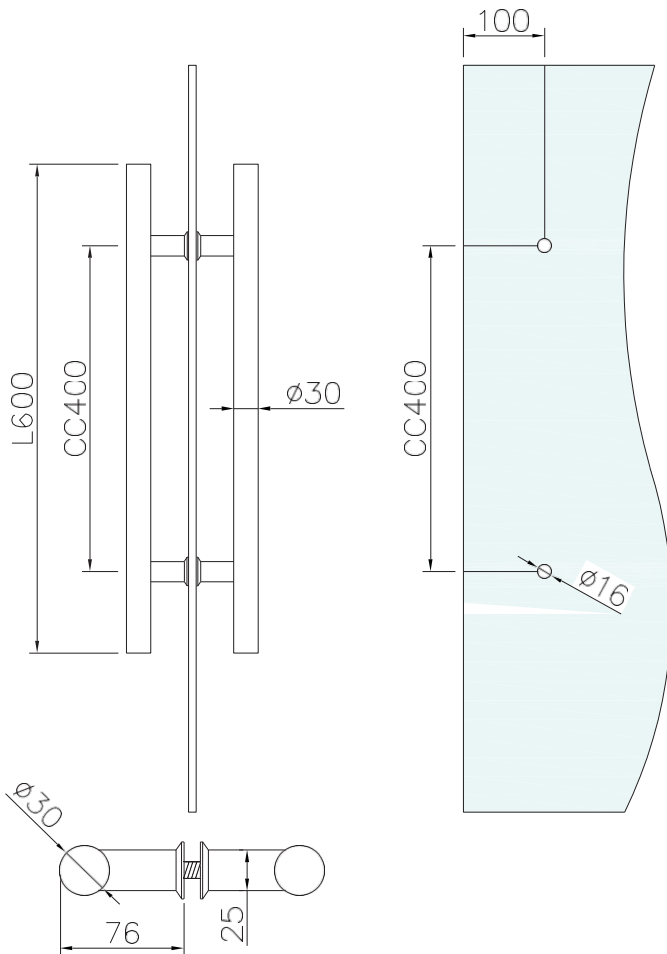

Disclaimer: Nerval makes every effort to provide accurate specification data. However, specification may change without notice. Please visit nerval website to see NERVAL'S TERMS AND CONDITIONS.